

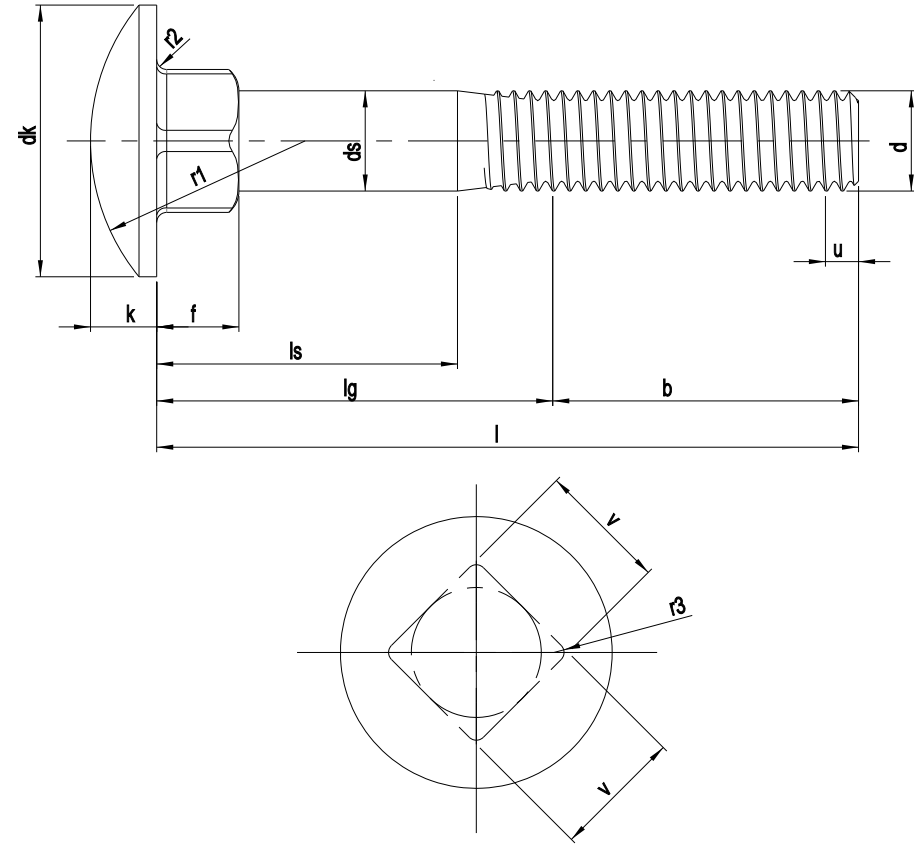

Further Information

Diameter (d)	Pitch	dk	k	v	f	b	b (L over 125)	b (L over 200)
M5	0.80	13.55-12.45	3.30-2.70	5.48-4.52	4.10-2.90	16	22	*
M6	1.00	16.55-15.45	3.88-3.12	6.48-5.52	4.60-3.40	18	24	*
M8	1.25	20.65-19.35	4.88-4.12	8.58-7.42	5.60-4.40	22	28	41
M10	1.50	24.65-23.35	5.38-4.62	10.58-9.42	6.60-5.40	26	32	45
M12	1.75	30.65-29.35	6.95-6.05	12.70-11.30	8.75-7.25	30	36	49
M16	2.00	38.80-37.20	8.95-8.05	16.70-15.30	12.90-11.10	38	44	57



 PRECISION TECHNOLOGY SUPPLIES Stainless Steel Industrial Fastenings & Precision Turned Parts	Part No. A60308120
www.pts-uk.com +44 (0)1342 410758	M8 X 120 CARRIAGE BOLT DIN 603 A2 STAINLESS STEEL
Information in this drawing is provided for reference only	