

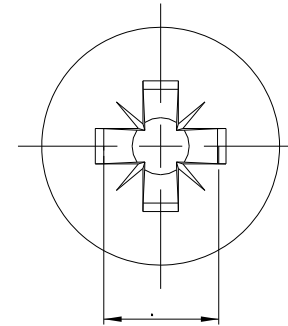

## Further Information

Diameter	Pitch	dk	k (max)	Drive
M1.6	0.35	3.00-2.75	0.96	#0
M2	0.40	3.80-3.50	1.20	#1
M2.5	0.45	4.70-4.40	1.50	#1
M3	0.50	5.60-5.30	1.65	#1
M3.5	0.60	7.30-6.14	1.93	#2
M4	0.70	7.50-7.14	2.20	#2
M5	0.80	9.20-8.84	2.50	#2
M6	1.00	11.00-10.57	3.00	#3
M8	1.25	14.50-14.07	4.00	#4
M10	1.50	18.00-17.57	5.00	#4

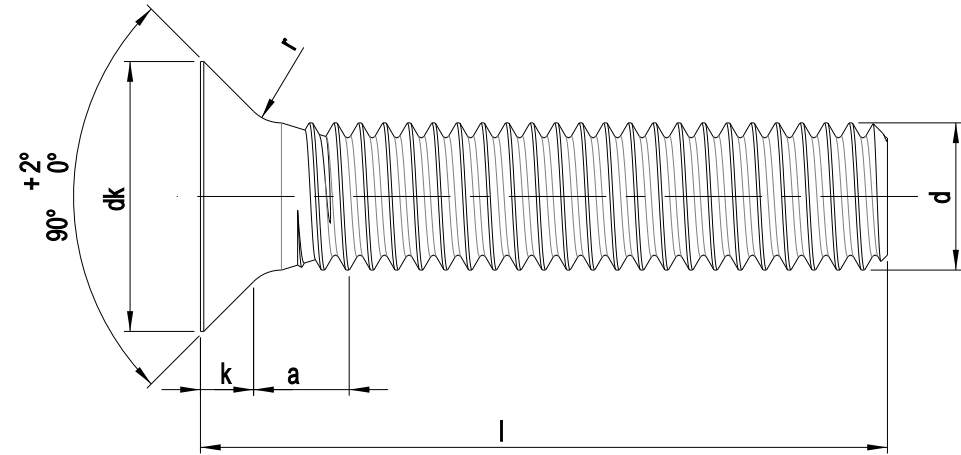

 <b>PRECISION TECHNOLOGY SUPPLIES</b> <small>Stainless Steel Industrial Fastenings &amp; Precision Turned Parts</small>	<b>Part No. A9650406</b>
<a href="http://www.pts-uk.com">www.pts-uk.com</a> +44 (0)1342 410758	<b>M4 X 6 POZI COUNTERSUNK            MACHINE SCREW DIN 965Z A2            STAINLESS STEEL</b>
Information in this drawing is provided for reference only	