

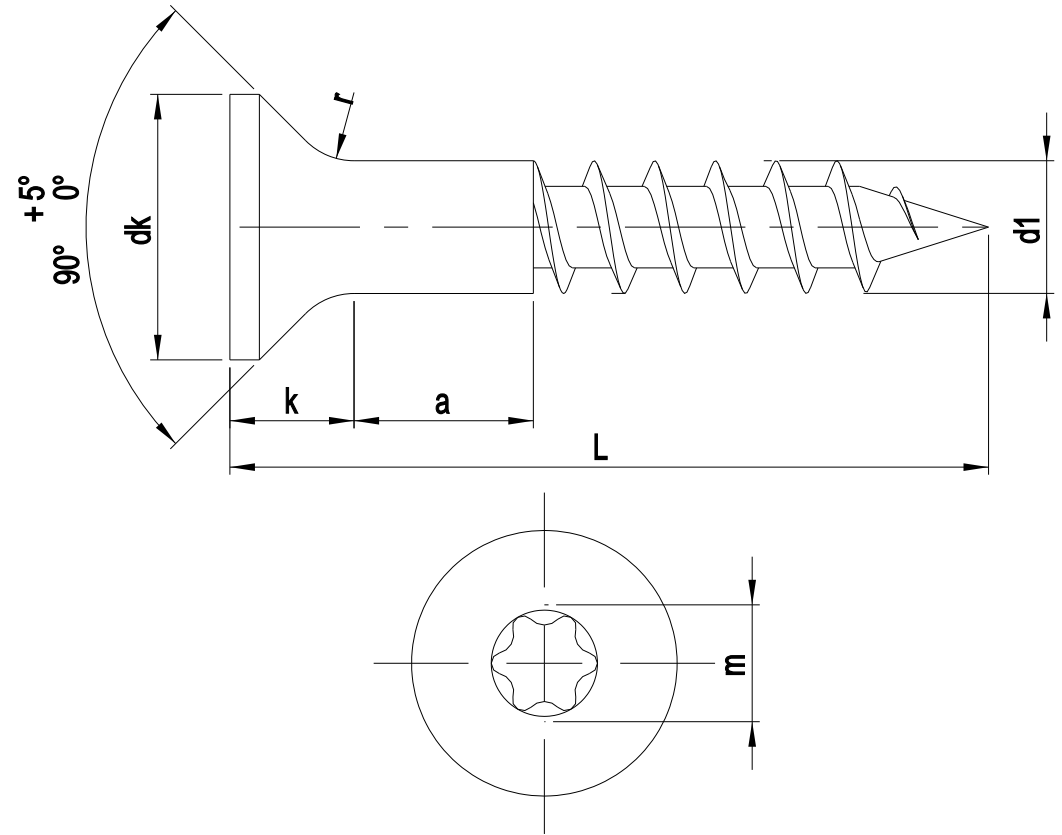

Further Information

Size	dk	k (nom)	b	Drive
3.0 (#4)	6.00-5.70	1.80	0.6 X L, max=24	T10
3.5 (#6)	7.00-6.64	2.00	0.6 X L, max=30	T10
4.0 (#8)	8.00-7.64	2.35	0.6 X L, max=42	T20
4.5 (#9)	9.00-8.64	2.55	0.6 X L, max=60	T20
5.0 (#10)	10.00-9.64	2.85	0.6 X L, max=70	T25
6.0 (#14)	12.00-11.57	3.35	0.6 X L, max=70	T25
8.0 (#16)	x	x	0.6 X L, max=80	T40
10 (#20)	x	x	0.6 X L, max=105	T40



 PRECISION TECHNOLOGY SUPPLIES <small>Stainless Steel Industrial Fastenings & Precision Turned Parts</small>	Part No. ACHIPTC04535A4
www.pts-uk.com +44 (0)1342 410758	4.5 X 35 TX20 COUNTERSUNK CHIPBOARD SCREW A4 STAINLESS STEEL
Information in this drawing is provided for reference only	