

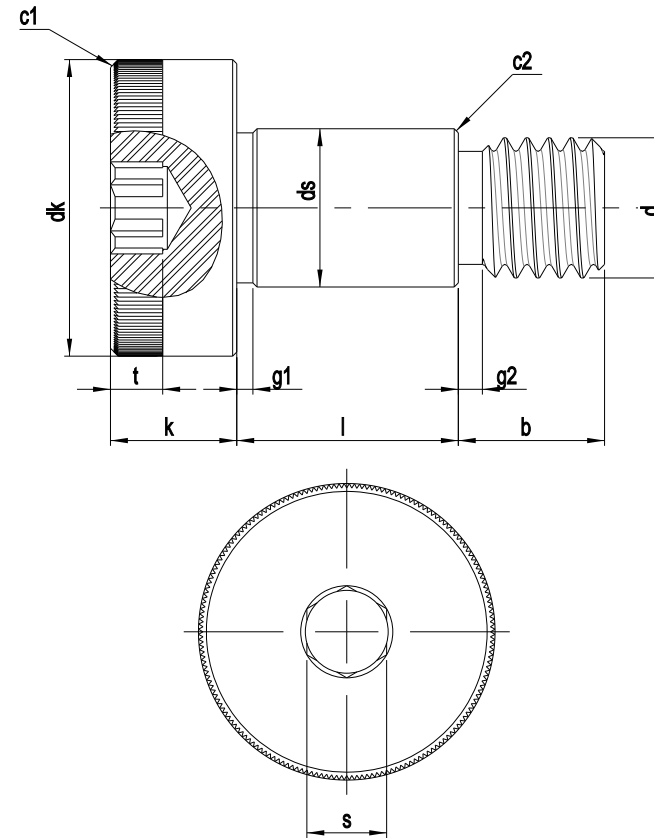

Further Information

ds (nom)	ds	d	s	dk	k	b
3.0	2.990-2.960	M2	2.0	5.0	2.0	3.8
4.0	3.990-3.960	M3	2.0	6.0	3.0	4.5
5.0	4.990-4.960	M4	2.5	9.0	4.0	4.5
6.0	5.990-5.960	M5	3.0	10	4.5	9.5
8.0	7.987-7.951	M6	4.0	13	5.5	11
10	9.987-9.951	M8	5.0	16	7.0	13
12	11.984-11.9	M10	6.0	18	9.0	16
	41					
16	15.984-15.9	M12	8.0	24	11	18
	41					
20	19.980-19.9	M16	10.0	30	14	22
	28					



 <p>PRECISION TECHNOLOGY SUPPLIES Stainless Steel Industrial Fastenings & Precision Turned Parts</p>	<p>Part No. ASS080616KA4</p>
<p>www.pts-uk.com +44 (0)1342 410758</p>	<p>8.0 (M6) X 16 KNURLED HEAD SOCKET SHOULDER SCREW A4 (316L) STAINLESS STEEL</p>
<p>Information in this drawing is provided for reference only</p>	